

DNAKE



User Manual

DNAKE AC01

REMARK

Please follow the user manual for correct installation and testing. If there is any doubt please call our tech-supporting and customer center.

Our company applies ourselves to reformation and innovation of our products. No extra notice for any change. The illustration shown here is only for reference. If there is any difference, please take the actual product as the standard.

The product and batteries must be handled separately from household waste. When the product reaches the end of service life and needs to be discarded, please contact the local administrative department and put it in the designated collection points in order to avoid the damage to the environment and human health caused by any disposal. We encourage recycling and reusing the material resources.

CATALOG

PRODUCT FEATURE	1
TECHNICAL PARAMETER	1
PACKAGE CONTENT	2
OVERVIEW	3
BASIC OPERATION	4
WEB SETTING	5
SYSTEM DIAGRAM	16
DEVICE WIRING	17
INSTALLATION	20
TROUBLESHOOTING	26
SAFETY INSTRUCTION	27

PRODUCT FEATURE

1. 50mm width slim design, suitable for narrow installation scenario
2. Aluminum alloy and 2.5D tempered glass
3. Multiple unlock method includes: RFID, NFC, Bluetooth, App remotely unlock
4. Support Wiegand & RS485
5. Flush mounted & surface mounted
6. IP65 & IK08

TECHNICAL PARAMETER

Power Supply: PoE or DC 12V/2A

RFID Reader:13.56MHz and 125kHz

Working Temperature: -40°C to +55°C

Storage Temperature: -40°C to +70°C

Working Humidity: 10% to 90% (non-condensing)

PACKAGE CONTENT

MODEL: AC01 (Surface mounting)

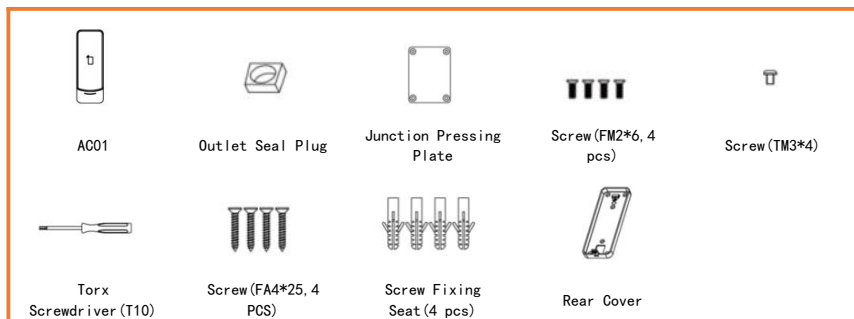

MODEL: AC01 (Flush mounting)

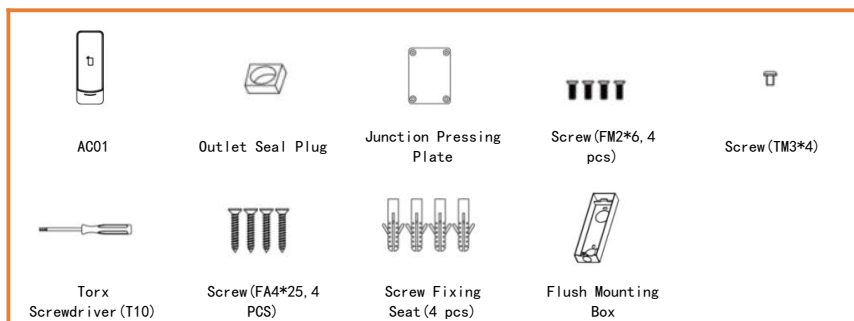

OVERVIEW

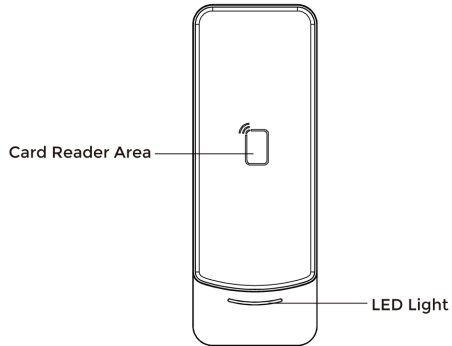

Note:

LED light: The light is used to display the running status of the device and the unlocking status

Relay Outputs: Supports 1 relay output.

BASIC OPERATION

1. Add Cards by Admin Card

1.1. Add other cards

Step 1: Tap the admin card once;

Step 2: And then tap other cards immediately. Other cards you have tapped can be used to open the door;

Step 3: Tap the admin card again to finish.

1.2. Delete other cards one by one

Step 1: Tap the admin card twice;

Step 2: And then tap other cards immediately. Other cards you have tapped will be deleted;

Step 3: Tap the admin card again to finish.

1.3. Delete all other cards

Tap the admin card five times. All the other cards will be deleted.

Tips: The admin card can only be used to manage cards. It cannot be used to open the door.

2. IP Broadcasting

If you want to check the IP address of the device, you can short press the RESET button of the device, and the device will broadcast the current IP address.

WEB SETTING

Connect Access Control and PC to a network switch in the same LAN. You can enter the IP address of Access Control in the web browser search bar and log in with the default account (admin) and password (123456). This is where you can configure the device.

To get the IP address, you can search by DNAKE Remote Upgrade Tool installed in the same LAN with the devices.

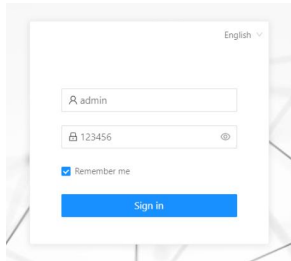

1. Information

1.1. Information

When you first log in to the web interface, you can find basic information displayed in this dashboard.

Product		
Model	Firmware Version	MAC Address
AC01	170AC.Cloud.V1.8.0_B_20250212	BCF8:11:00:EA:68
Firmware	UI	MCU
1.0.0 20250124	1.1.0 20250124	0
Register to Cloud	Unregistered	

Network		
DHCP	IP Address	Mask
Enabled	192.168.54.108	255.255.255.0
Gateway	DNS	

Model:	Model of the device;
Firmware Version:	Firmware version of the device;

MAC Address:	MAC address of the device;
Framework:	Framework of the device;
UI:	UI of the device;
MCU:	MCU of the device;
Register to Cloud:	Check the connection status of the device to the cloud platform
DHCP:	Status of DHCP;
IP Address:	Current IP address of the device;
Mask:	Subnet mask of the device;
Gateway:	Gateway of the device;
DNS:	Domain Name Server of the device;
Status:	Status of SIP registration of the device;
CMS IP:	IP address of CMS;
Status:	Status of CMS registration;

2. General

2.1. General > Basic

Device, Volume and Tamper of the device can be configured in this column.

Automatic Deployment:	Turn on or off Automatic deployment;
Project ID:	It is used to configure the automatic deployment function of the device. After creating a project on the cloud platform,

	fill in the Project ID here and the device will be automatically added to the project;
Building No. :	Number of the Building (Range: 1-999) ;
Unit No. :	Number of the Unit (Range: 1-99) ;
Apartment No. :	Number of the Apartment (Range: 1-9899) ;
Device No.	Number of the Device (Range: 1-99) ;
Volume :	Volume of system can be set from 1 to 6 ;
Tamper :	Enable to use Tamper alarm on the back of the device ;

2.2. General > Time

Time of the device can be configured. Daylight Saving Time is also supported.

Auto (Time) :	Enable to synchronize computer time;
Date &Time :	Date and time can be set manually;
NTP URL :	Network Time Protocol (NTP) is a protocol used to synchronize computer time;
Time Zone :	A region that observes a uniform standard time;
Daylight-saving Time :	Enable to set DST;
Start Time :	The beginning of DST;
End Time :	The ending of DST;
Offset Time :	The default value is 60 minutes;

2.3. General > Network

The device network can be set to either DHCP or a static IP address.

CMS parameters should be configured here when you try to register this device to CMS.

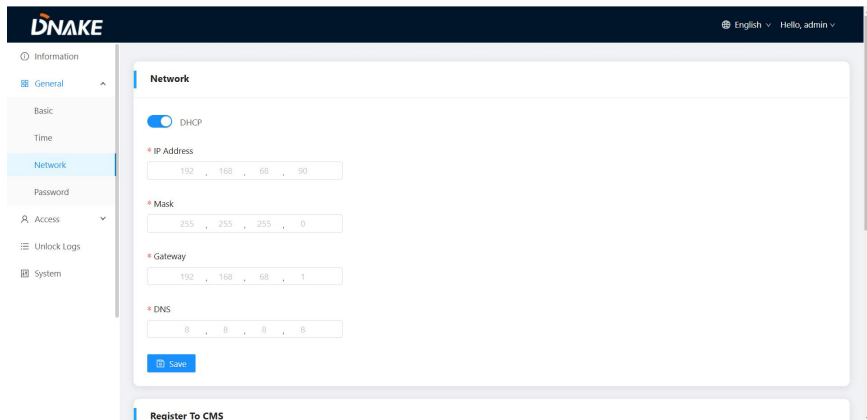

DHCP:	Enable DHCP (Dynamic Host Configuration Protocol) to dynamically distribute network configuration parameters;
IP Address:	Configure Static IP address to manually distribute network configuration parameters;
Mask:	Subnet mask;
Gateway:	A component that is part of two networks, which use different protocols;
DNS:	Domain Name Server of the device;
Wi-Fi:	Search and connect to Wi-Fi to access the Internet;
CMS:	Enable to use CMS software to manage devices;
CMS IP:	Server address of CMS;
Cloud Platform:	Turn on or off the cloud platform connection

2.4. General > Password

The Web password is for the administrator to log in settings on the web.

The default password is 123456.

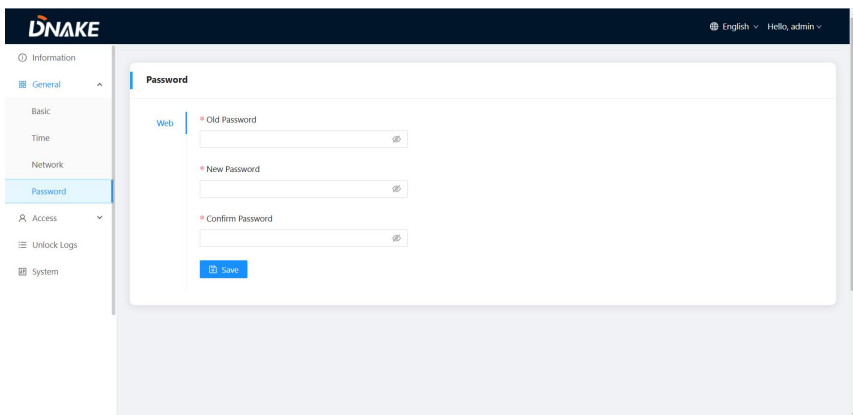

Web Old Password:	Current administrator password of the web (Default 123456);
Web New Password:	New administrator password of the web;
Web Confirm Password:	Confirm administrator password of the web;

3. Access

3.1. Access > Access Control

Relays, Access Cards, Wiegand Transfer Mode and Event Storage can be configured here.

Unlock Delay:	The length of unlock delay time (0-9s);
Unlock Time:	The length of unlock time (1-9s);
Dry Contact Input 1-2:	3 modes of dry contact inputs are supported (Exit Button, Door Sensor, Fire Linkage);
Master Card:	Click read to add Master card to manage cards;
Card Reading Mode:	When reading the card, the card information will display different data according to different modes (Dnake Mode or Full Card No.);
Card Order:	Select the reading order, which affects how the card data is displayed (Normal or

	Reversed);
Card Display Mode:	Select the card information display format (Hexadecimal or Decimal);
Mifare Card Encryption:	Enable or disable the Mifare Card Encryption;
Sector:	Select the sector to read the Mifare card (0~15);
Block:	Select the block of sector to read the Mifare card (0~3);
Block Key:	You can enter the Mifare card's encryption key here;
Wiegand Transfer Mode:	Select Transfer Mode of Wiegand port (Input or Output);
Wiegand Output Bits:	Select Output Bits (26, 34 or 58);
Wiegand Output Type:	Select Output Type;
Wiegand Input Bits:	Select Input Bits (26, 34 or 58)
Wiegand Input Type:	Select Input Type;
Event Storage:	When the unlocking record is full, if you want to store a new unlocking record, the device will delete the entry from beginning. You can set the specific quantity (0~999, Default is 300);

3.2. Access > User

Person column is for access authorization. You can add users to the device and relate them with relays or cards.

Information

General

Access

Access Control

User

Unlock Logs

System

User

Local Cloud

Name Apartment No. Card No.

<input type="checkbox"/>	No.	Name	Apartment No.	User Type	Card No.	Relay	Status	Action
<input type="checkbox"/>	1	234	None	Resident	129632	1	Enabled	✎

< 1 >

Information

General

Access

Access Control

User

Unlock Logs

System

Add

Status:

* User ID:

User Type: Resident

* Name: 0 / 26

Card No.:

Apartment No.: 0 / 18

Number of Passes:

Effective Time:

* Number:

2025-02-20 → 2055-02-20

Relay: Relay1

Start time → End time

All

Mon Tue Wed Thur

Fri Sat Sun

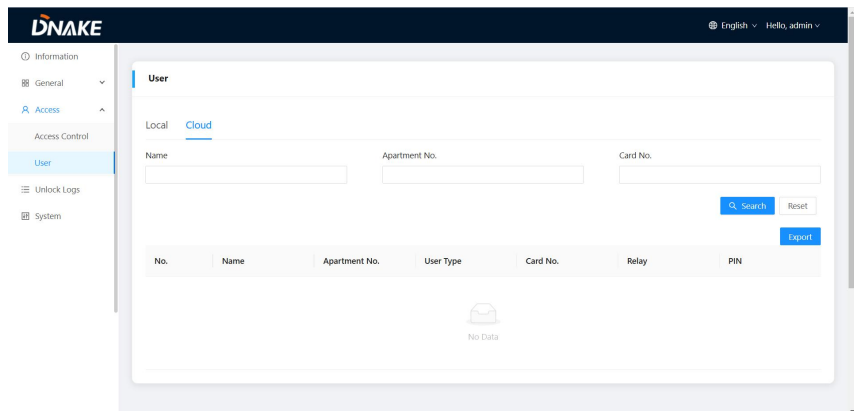

Search:	Fill in text inputs to search;
Reset:	Click reset to clear words in text inputs;
Delete All:	Delete all data on the chart;
Import:	Import all data to the chart;
Export:	Export all data on the chart;
Add:	Add users to Access Control; Fill in the User ID, Name, Apartment No, Number of Passes, choose the Relay, User Type, Card No and Effective Time to add users.
Cloud:	The cloud platform will sync user information to the local device, you can check it in the Cloud column

4. Unlock Logs

4.1. Unlock Logs

It can support 100000 unlock logs at mot. If the logs are more than 100000, the previous logs will be covered;

Unlock Logs

Name: User ID: User Type:

Unlock Type: Unlock Time: Start date: → End date:

Selected 1

No.	User ID	Name	User Type	Unlock Type	Number	Status	Relay	Unlock Time
<input checked="" type="checkbox"/> 1	None	None	None	Card	D501FA60	Failed	None	2025-02-20 09:27:28
<input type="checkbox"/> 2	None	None	None	Card	04258C32AA7780	Failed	None	2025-02-20 09:17:08
<input type="checkbox"/> 3	None	None	None	Card	04258C32AA7780	Failed	None	2025-02-20 09:17:04
<input type="checkbox"/> 4	None	None	None	Card	04258C32AA7780	Failed	None	2025-02-20 09:17:03

Name:	The name of the person you add;
User ID:	The User ID you set on user column.
Unlock Type:	The type of Unlock Logs, including Card, Exit button, BLE and APP;
Unlock Time:	The Unlock Logs will be filtered by the Date &Time you set;
Search:	Fill in text inputs to search;
Reset:	Click reset to clear words in text inputs;
Delete All:	Delete all data on the chart;
Export:	Export all data on the chart;

5. System

5.2. System

The system column is designed for data backup and restore, firmware upgrade, factory default, device reboot, packet capture and logs capture.

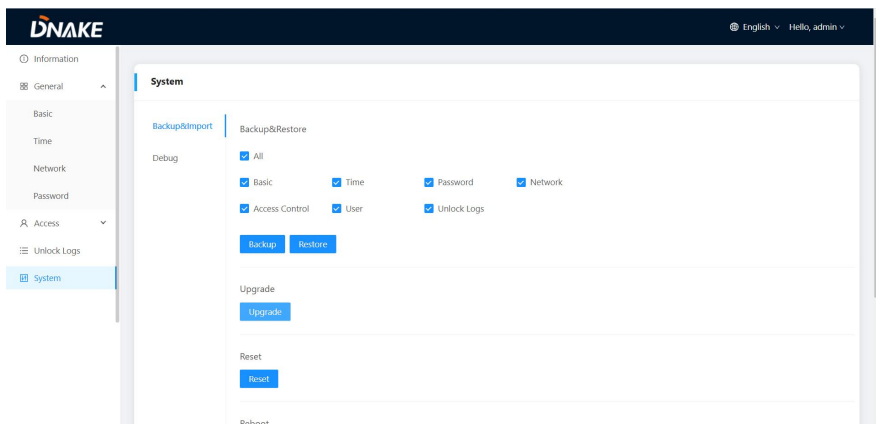

SYSTEM DIAGRAM

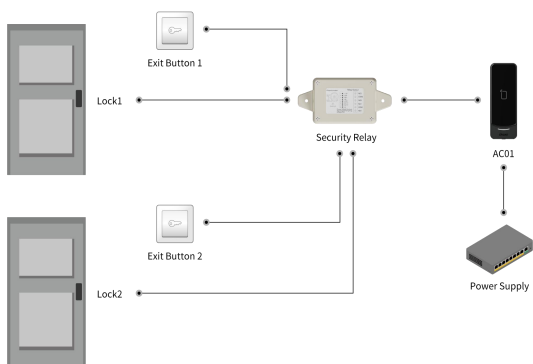
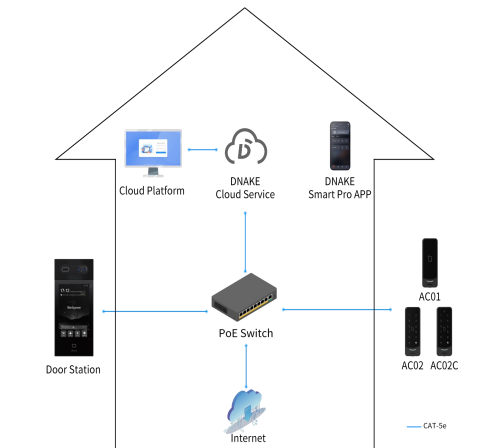

DEVICE WIRING

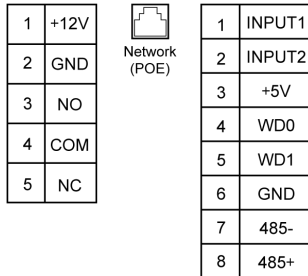

1. Network (PoE)

Standard RJ45 interface is for the connection with PoE switch or other network switch.

PSE shall comply with IEEE 802.3af (PoE) and its output power not less than 15.4W and its output voltage not be less than 50V.

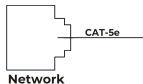

2. Power/Switching Value Output

The power interface of Access Control connects to 12V DC power.

Connect to the lock module (an independent power supply is necessary for the lock).

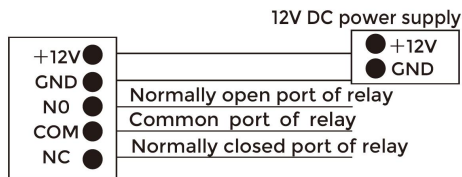

Warning!

1. When connecting to an inductive load device such as a relay or electromagnetic lock, you are recommended to use a diode 1A/400V (included in the accessories) in anti-parallel with the load device to absorb inductive load voltage peaks. The access control will be better protected in this way.
2. The load current of the relay cannot be greater than 2A. See attached picture for more details.

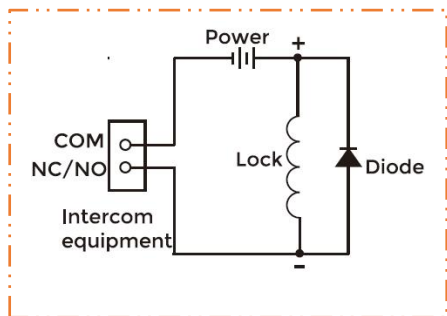

3. Custom input configuration interface/Wiegand/RS485

- The input interface can be configured with various functions, such as the exit button, door status sensor, and fire linkage interface.
- The interface can be connected to one IC/ID card reader or be used for reading the information of built-in card reader. Card swiping device connected to Wiegand interface.
- +5V can power the Wiegand card swiping device, note that the current must not exceed 100mA.
- Enable to connect equipment with RS485 interface. Connect to the lock module (independent power supply is necessary for the lock).

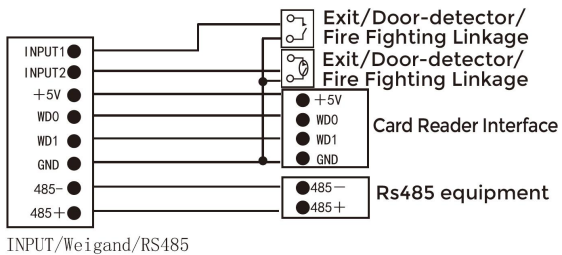

Note: Access Control can only be connected to one card reader or management device at a time.

INSTALLATION

Installation of Flush Mounting

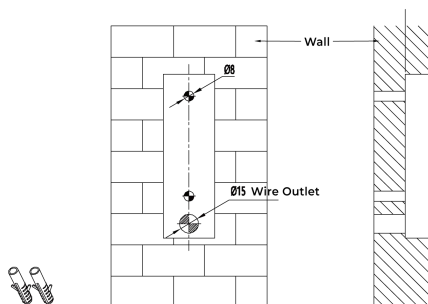

1. Choose the suitable height , and put the label sticker on the wall.
2. According to the sticker, drill three 8 x 45mm for screws and one 5mm for wire outlet.
3. Remove the sticker after drilling.

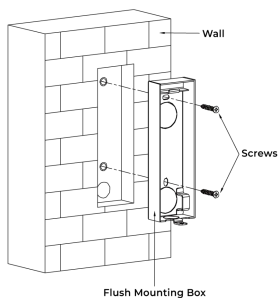

4. Lock the Flush Mounting Box with 2 screws.

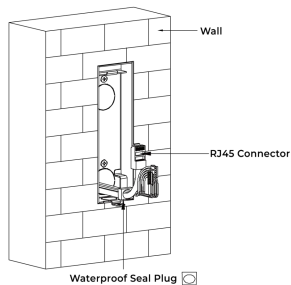

5. Let wires (included) and network cable without RJ-45 plug go through rain hood and waterproof seal plug.

6. Connect RJ-45 Plug.

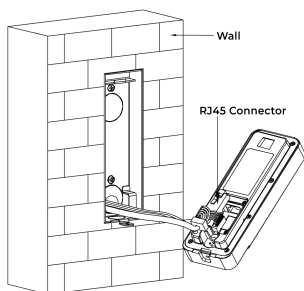

7. Plug waterproof seal plug into the cover groove at the bottom.

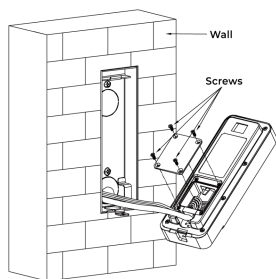

8. Fix interface clamp to the device with 4 screws.

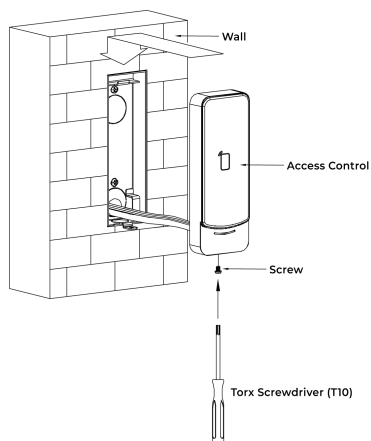

9. Use screwdriver to lock the bottom of the device with 1 screw

Installation of Surface mounting

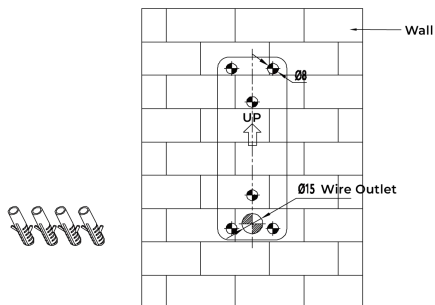

1. Choose the suitable height , and put the label sticker on the wall.
2. According to the sticker, drill three 8 x 45mm for screws and one 5mm for wire outlet.
3. Insert 4 screw fixing seats into the screw holes.
4. Remove the sticker after drilling.

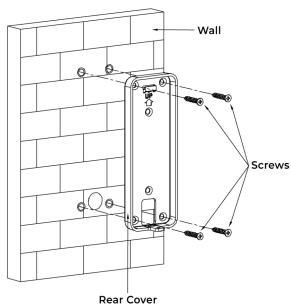

5. Lock the rear cover with 4 screws.

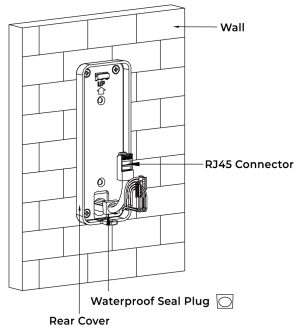

6. Let wires (included) and network cable without RJ-45 plug go through rear cover and waterproof seal plug.

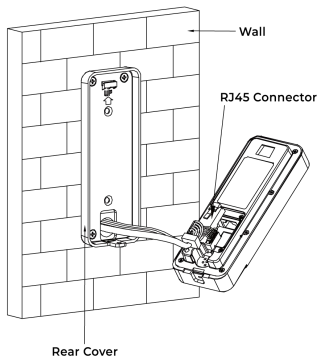

7. Connect RJ-45 Plug.

8. Plug waterproof seal plug into the cover groove at the bottom.

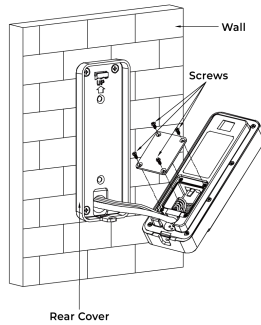

9. Fix interface clamp to the device with 4 screws.

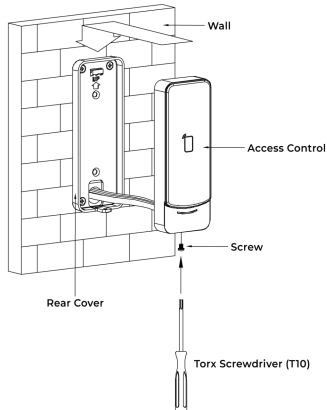

10. Hang up device with rear cover.

11. Use screwdriver to lock the bottom of the device with 1 screw

TROUBLESHOOTING

The Access Control cannot start up or power off automatically.

- Check whether it has power-failure, and power it on again
-

The Access Control did not get IP address.

- Check if the DHCP is enabled on Access Control.
 - Check whether the router can provide the IP address normally
-

No sound during the communication.

- Check whether the volume is set to the lowest.
-

Multimedia files cannot be played normally.

- Check whether the system supports the file format. Please refer to the multimedia setting for details.
-

Mifare SL3 card cannot be read in Access Control.

- The card reading mode needs to be 'Full Card No.'
 - Block Key needs to be entered correctly;
 - Select the correct sectors and blocks.
-

The temperature of device is too high.

- Long-term use leads to high temperature. It's normal and will not affect the device's use life and performance.
-

SAFETY INSTRUCTION

In order to protect you and others from harm or your device from damage, please read the following information before using the device.

- Do not install the device in the following places:
- Do not install the device in high-temperature and moist environment or the area close to magnetic field, such as the electric generator, transformer or magnet.
- Do not place the device near the heating products such as electric heater or the fluid container.
- Do not place the device in the sun or near the heat source, which might cause discoloration or deformation of the device.
- Do not install the device in an unstable position to avoid the property losses or personal injury caused by the falling of device.

Guard against electric shock, fire and explosion:

- Do not use damaged power cord, plug or loose outlet.
- Do not touch the power cord with wet hand or unplug the power cord by pulling.
- Do not bend or damage the power cord.
- Do not touch the device with wet hand.
- Do not make the power supply slip or cause the impact.
- Do not use the power supply without the manufacturer's approval.
- Do not have the liquids such as water go into the device.

Clean Device Surface

- Clean the device surfaces with soft cloth dipped in some water, and then rub the surface with dry cloth.

Other Tips

- In order to prevent damage to the paint layer or the case, please do not expose the device to chemical products, such as the diluent, gasoline, alcohol, insect-resist agents, opacifying agent and insecticide.
- Do not knock on the device with hard objects.

- Do not press the screen surface. Overexertion might cause flopover or damage to the device.
- Please be careful when standing up from the area under the device.
- Do not disassemble, repair or modify the device at your own discretion.
- The arbitrary modification is not covered under warranty. When any repair required, please contact the customer service center.
- If there is abnormal sound, smell or fume in the device, please unplug the power cord immediately and contact the customer service center.
- When the device isn' t used for a long time, the adaptor can be removed and placed in dry environment.
- When moving, please hand over the manual to new tenant for proper usage of the device.

FCC Warning

This device complies with Part 15 of the FCC Rules. Operation is subject to the following two conditions:

(1) This device may not cause harmful interference, and (2) this device must accept any interference received, including interference that may cause undesired operation.

NOTE 1: This equipment has been tested and found to comply with the limits for a Class B digital device, pursuant to part 15 of the FCC Rules. These limits are designed to provide reasonable protection against harmful interference in a residential installation. This equipment generates uses and can radiate radio frequency energy and, if not installed and used in accordance with the instructions, may cause harmful interference to radio communications. However, there is no guarantee that interference will not occur in a particular installation.

If this equipment does cause harmful interference to radio or television reception, which can be determined by turning the equipment off and on, the user is encouraged to try to correct the interference by one or more of the following measures:

- Reorient or relocate the receiving antenna.
- Increase the separation between the equipment and receiver.
- Connect the equipment into an outlet on a circuit different from that to which the receiver is connected.
- Consult the dealer or an experienced radio/TV technician for help.

NOTE 2: Any changes or modifications to this unit not expressly approved by the party responsible for compliance could void the user's authority to operate the equipment.

RF exposure statement

This equipment complies with the FCC radiation exposure limits set forth for an uncontrolled environment. This transmitter must not be co-located or operating in conjunction with any other antenna or transmitter.

 **EASY & SMART
INTERCOM
SOLUTIONS**