

DNAKE

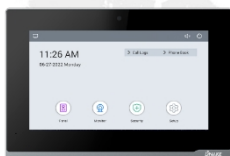

User Manual

DNAKE IPK04

REMARK

Please follow the user manual for correct installation and testing. If there is any doubt please call our tech-supporting and customer center.

Our company applies ourselves to reformation and innovation of our products. No extra notice for any change. The illustration shown here is only for reference. If there is any difference, please take the actual product as the standard.

The product and batteries must be handled separately from household waste. When the product reaches the end of service life and needs to be discarded, please contact the local administrative department and put it in the designated collection points in order to avoid the damage to the environment and human health caused by any disposal. We encourage recycling and reusing the material resources.

CATALOG

PRODUCT FEATURE	1
TECHNICAL PARAMETER	1
PACKAGE CONTENT	2
OVERVIEW	3
BASIC OPERATION	4
SYSTEM DIAGRAM	21
DEVICE WIRING	22
INSTALLATION	26
TROUBLESHOOTING	33
SAFETY INSTRUCTION	34
FCC WARNING	35

PRODUCT FEATURE

1. Plug & Play
2. Motion detection
3. Standard POE
4. One-touch calling
5. Remote unlocking
6. CCTV integration
7. 2MP HD digital WDR camera

TECHNICAL PARAMETER

Indoor Monitor E216

Power Supply: POE (802.3af) or DC 12V/2A

Standby Power: 1.5 W

Rated Power: 9 W

Display: 7-inch TFT LCD

Screen: Capacitive touchscreen

Resolution: 1024 x 600

Working Temperature: -10°C to +55°C; Storage Temperature: -40°C to +70°C

Working Humidity: 10% to 90% (non-condensing)

Door Station C112R

Power Supply: POE (802.3af) or DC 12V/2A

Standby Power: 1.5 W

Rated Power: 3 W

Video Resolution: 1920 x 1080

Working Temperature: -10°C to +55°C; Storage Temperature: -10°C to +55°C;

Working Humidity: 10% to 90% (non-condensing)

PACKAGE CONTENT

MODEL: IPK04



E216



Wiring Cover



PM4×20 (2 pcs)



Diode (3 pcs)



C112R



Screw Fixing Seat
(3 pcs)



PA4×25 (3 pcs)



Rear Cover



Rain Hood



Sealing Plug of
Wiring Port



Junction Pressing



PM2×6 (2 pcs)



FM3×6 (1 pcs)



FM3×6 (1 pcs)



Wrench Screw
(T10)



User Manual

OVERVIEW

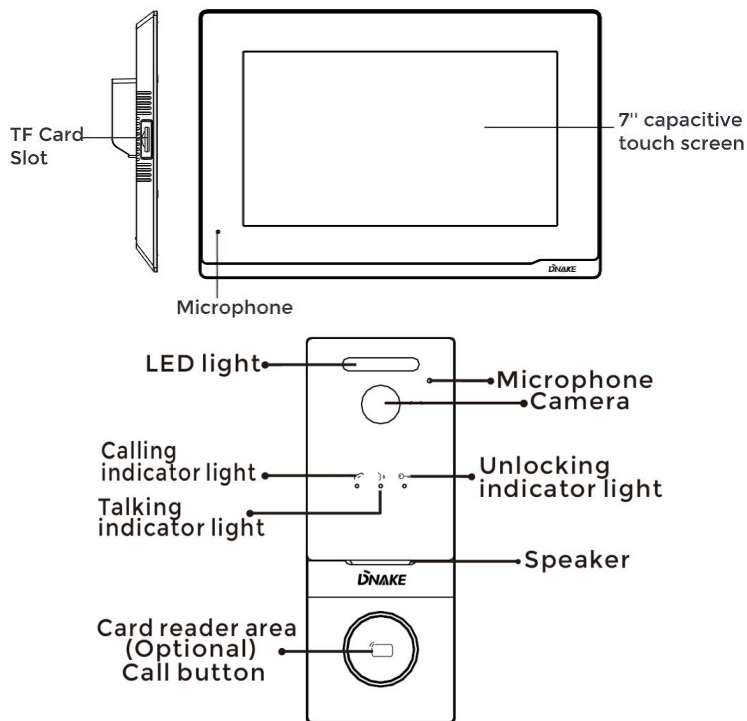

Note:

Calling indicator light: The 1st indicator light will activate if the call button is pressed.

Talking indicator light: The 2nd indicator light will activate if the call is picked up or the Door Station is being actively monitored.

Unlocking indicator light: The 3rd indicator light activates for 3 seconds when the door is unlocked.

Relay Outputs: Supports 1 relay outputs.

BASIC OPERATION

1. Onboarding

1.1. Language 1/3

Language is the first setting. We have 16 kinds of languages (Chinese Simplified, Chinese Traditional, English, Spanish, German, Polish, Russian, Turkish, Hebrew, Arabic, Portuguese, French, Italian, Slovak, Vietnamese, and Dutch) for customers to choose from. Click Next to move on.

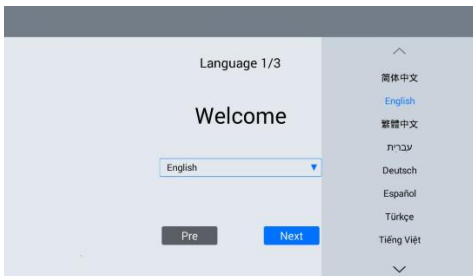

1.2. Indoor Monitor Settings 2/3

1. Is it your first Indoor Monitor?

If yes, this Indoor Monitor will be regarded as the main one. If not, your first Indoor Monitor will be the main one while this one will be the subordinate one.

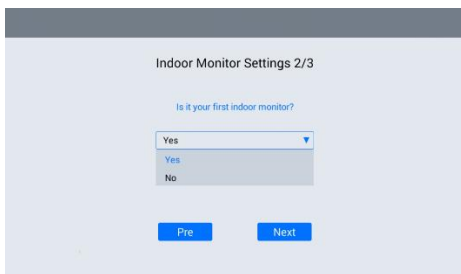

2. Network of Indoor Monitor

The network of Indoor Monitor can be either dynamic or static. Select DHCP to enable dynamic network or fill in IP, Mask, and Gateway to set up static network for Indoor Monitor.

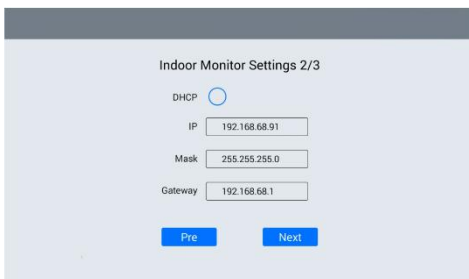

1.3. Door Station Sync 3/3

1. Searching Door Station.

Door Station should be connected to the same LAN as Indoor Monitor's when Indoor Monitor is searching Door Station.

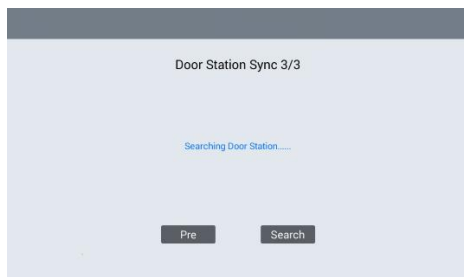

Please check network and devices if not found. Click Search to try again.

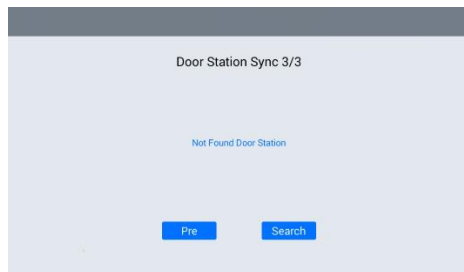

2. Select Door Station.

Select Door Station and MAC of Door Station will appear. Click MAC of Door Station to Sync.



3. Network of Door Station

Network of Door Station can be either dynamic or static. Select DHCP to enable a dynamic network or fill in IP, Mask and Gateway to set up a static network for Door Station. Network segment should be the same as Indoor Monitor's when using a static IP address. For example, IP address should be 192.168.0.** if the IP address of Indoor Monitor is 192.168.0.**.



4. Name Door Station

A name should be given to Door Station to differentiate Door Station. Text box is above the preview video frame of Door Station.



5. Settings Completed

It's coming to an end here. All the basic settings are done.

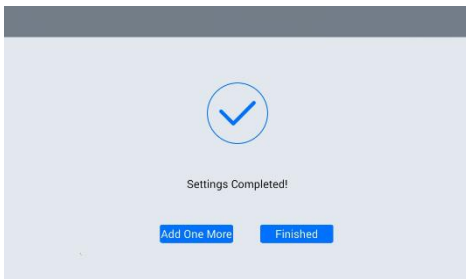

6. Connect Smart Life APP

Scan QR code on the left to download Smart Life APP. User should register an account and log in with email address. Scan QR code on the right to add this device to mobile phone. Please refer to **6. Add Door Station to Resident's Phone** for more details of Smart Life app.

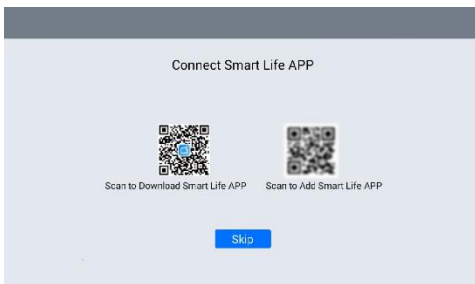

2. Call Indoor Monitor by Door Station

2.1. Call Indoor Monitor by Door Station

1. Try to call Indoor Monitor. Press the Button on Door Station to make this call.
2. You can answer, reject, open the door, or speak with the visitor.



3. Monitor Door Station on Indoor Monitor

3.1. Monitor Door Station on Indoor Monitor

1. Press Panel on Indoor Monitor to monitor Door Station.

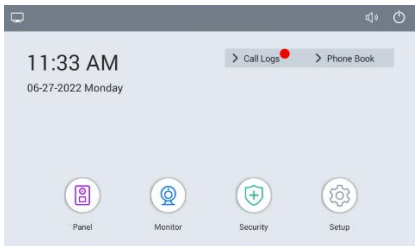

2. If you have two Door Stations connecting to Indoor Monitor, you need to switch devices in the upper right corner of the Panel page to watch the real-time pictures from Door Station. Before switching, you need to press Pause in the bottom right to make sure of a smooth transition.



4. Add Cards by Admin Card

4.1. Add Cards by Admin Card

1. Add an admin card to the device:

After having finished Onboarding successfully, resident can tap a card to the card reader area of Door Station. Admin card is ready to be used to manage all cards.

2. Manage other cards by admin card:

a) Add other cards: Tap your admin card once and then tap other cards immediately. Other cards you have tapped can be used to open the door. Tap admin card again to finish.

b) Delete other cards one by one: Tap your admin card twice and then tap other cards immediately. Other cards you have tapped will be deleted. Tap admin card again to finish.

c) Delete all other cards: Tap your admin card five times. All the other cards will be deleted.

Please note that admin card can only be used to manage cards. It cannot be used to open the door.

3. Remove mistakenly added Admin card by factory defaulting Door Station.

Step 1: Go to Setup > Devices.



Step 2: Click Door Station and click trash bin to delete.

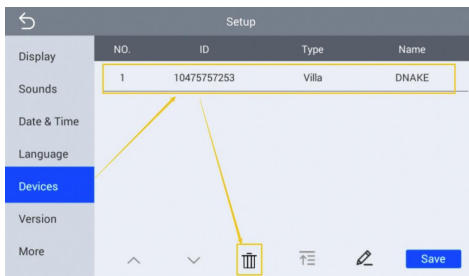

Step 3: Door Station will disappear which means Door Station has been factory defaulted, and admin card is removed.

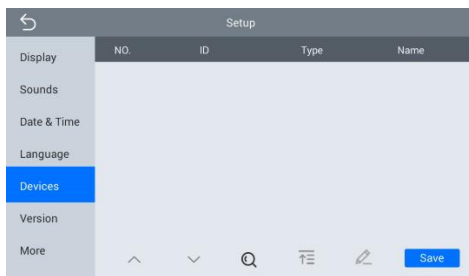

Step 4: Click the little search icon below.

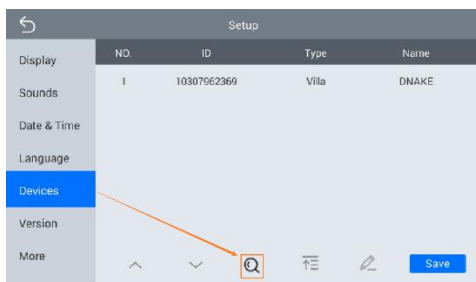

Step 5: Onboarding page will guide to set up Door Station. Please refer to 1.3 Door Station Sync 3/3.

5. IP Camera Monitoring

5.1. IP camera monitoring

1. Connect the Ethernet cable to both IP Camera and Indoor Monitor. Please keep them under the same LAN.

2. Add IP Camera to the Indoor Monitor on the website:

Step 1: You can double click IP address of the Indoor Monitor on the page of Remote Upgrade to open the website. You can also put Indoor Monitor's IP address in the browser's search bar to log in its webpage with account: user and password:1234.

Step 2: Go to IPC to name IP camera and type in URL.URL contains the account, password, and Ip address. Make sure the URL of the IP Camera is

right. Do not forget to submit it. Please get your IPC RTSP stream URL from Internet or IPC provider.



3. Monitor IP Camera on Indoor Monitor

Step 1: Go to home page of Indoor Monitor.

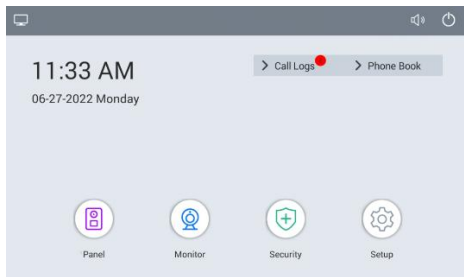

Step 2: Click Monitor to enter the monitoring page and click the upper camera icon to monitor the camera.



The followings are introductions about the buttons to control monitoring of cameras:

The name of IP Camera is in the upper right corner for switching the cameras

The upper camera icon is for starting monitoring and the pause key is down below.

5.2. Switch the video between Door Station and IP camera

1. Connect the Ethernet cable to IP Camera, Door Station, and Indoor Monitor. Please keep them under the same LAN.

2. Add IP Camera to Door Station on the website:

Step 1: You can double click IP address of the Door Station on the page of Remote Upgrade to open the website. You can also put Door Station's IP address in the browser's search bar to log in its webpage with account: admin and password:123456

Step 2: Go to Advanced > Video to select RTSP Feed and type in URL. URL contains account, password, and IP address. Make sure URL of the IP Camera is right. Do not forget to Save.

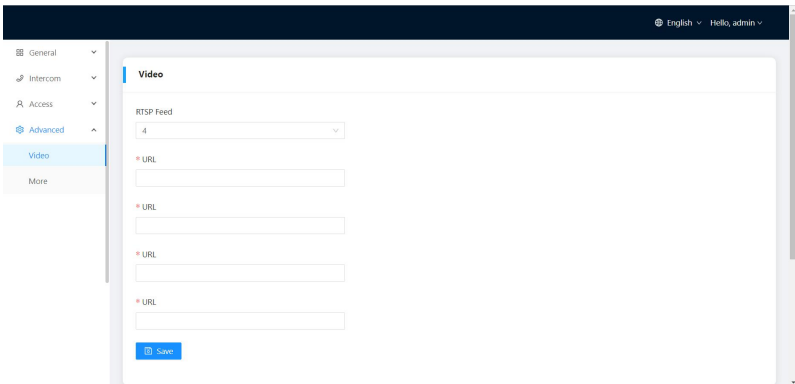

3. Switch the video between Door Station and IP camera.

Step 1: Call Indoor Monitor by Door Station and answer the call on Indoor Monitor.



Step 2: Click the little Keyboard icon.

Step 3: You can switch the video between Door Station and IP camera by clicking number 1 and number 2 on the keyboard of the Monitoring screen you have just unfolded. You can open the door by pressing * and #.



Step 4: Click the little Keyboard icon to fold the keyboard panel so that you can see the whole monitoring screen.

6. Add Door Station to Resident's Phone

6.1. Download Smart Life app

Resident can also download the Smart Life app by searching for Smart Life in app store, Google Play Store or by scanning the following QR code.



Smart Life App

6.2. Register, log in

1. Open the Smart Life app and tap Sign Up. In the User Agreement and Privacy Policy dialog box, carefully read the privacy policy and agreement and tap Agree to go to the account registration page.

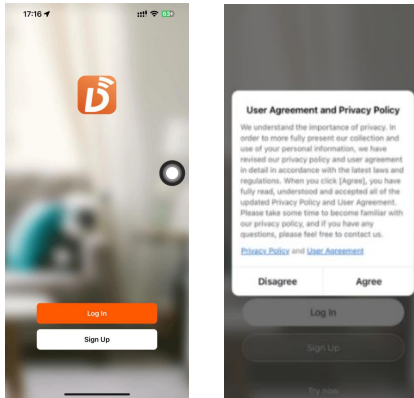

2. Enter resident's email address and tap Get Verification Code. The country or region on the registration page is the same as that resident set in the mobile phone. Resident can also manually change the country or region before registration.

3. On the Enter Verification Code page, enter the verification code. On the Set Password page, set the password as per instructions and tap Done.

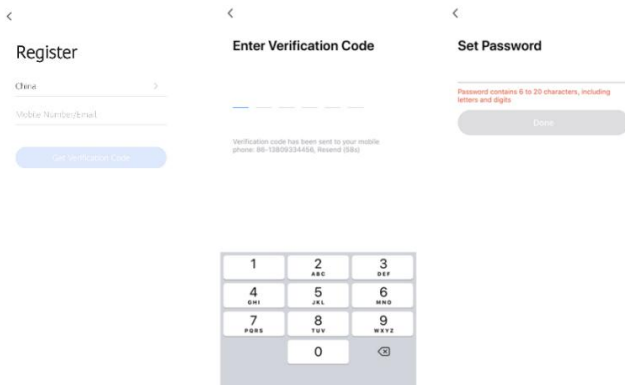

6.3. Scan QR code

1. License of Smart Life app will be filled in Indoor Monitor before delivery.

Step 1: Go to home page of Indoor Monitor.

Step 2: Click QR code in the upper right corner.

Step 3: Scan QR code. One QR code can only be bound to one phone but resident can share resident's authority to its family members up to 20 users.

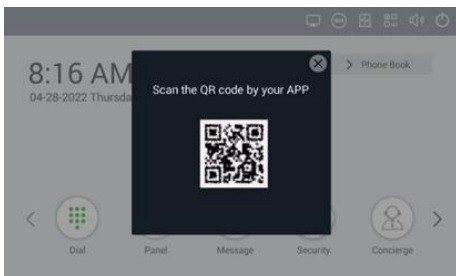

2. Congratulations. Door Station is successfully connected to resident's phone.

3. After resident complete the above steps, the Smart Life app will automatically

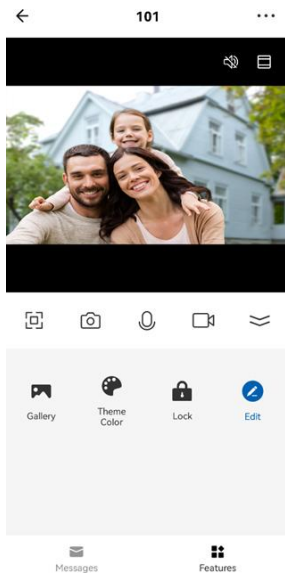

Switch to full screen



Take a screenshot



Record a video



Expand more



Messages



Features (Gallery, Theme Color, Lock, Edit)



Gallery



Theme Color (Light Mode & Dark Mode)



Unlock remotely



Edit (Button Management)

enter the interface of monitor. Resident can make a video call to Door Station

and unlock remotely on the smartphone. If Door Station is calling in, Indoor Monitor and Smart Life App can ring at the same time, and the mobile phone APP can answer the call and unlock remotely. Smart Life App can also monitor and unlock Door Station.

6.4. Rename devices

1. After scanning the device, resident will see the reminder (Added successfully). In this page, resident can edit the name and room of this device.

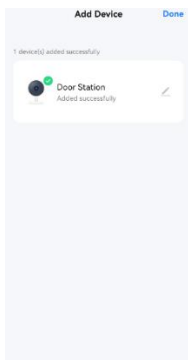

2. After the device is added, resident can customize the device name. The following steps and pictures are here for reference.

Step 1: Back to the home page and click the device to rename.

Step 2: Click Edit in the upper right corner.

Step 3: Select the icon.

Step 4: Click Name.

Step 5: Rename device.

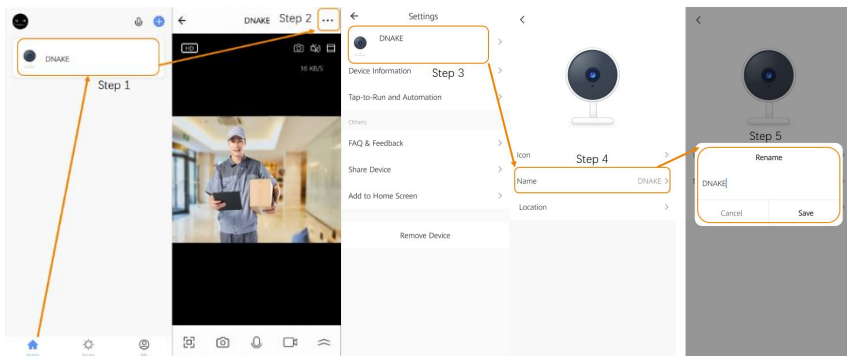

6.5. Share devices

1. Resident can create a home to share resident's devices in this group. The following steps and pictures are here for reference.

Step 1: Go to Me page and then open Home Management.

Step 2: Select My Home or Create a Home.

Step 3: In the Home Setting page, resident can rename, locate, or share resident's device.

Step 4: Wait for new members to accept resident's invitation.

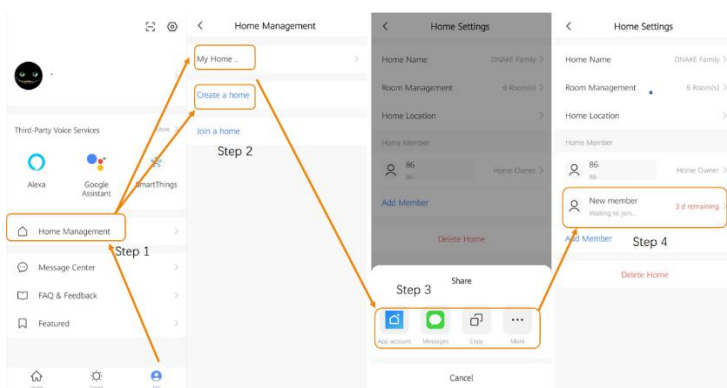

7. Add Subordinate Indoor Monitor

7.1. Add subordinate Indoor Monitor

1. After having added first Indoor Monitor successfully, resident can add more

subordinate Indoor Monitors to it. The maximum amount of Indoor Monitor is six.

Step 1: Connect subordinate Indoor Monitor to the same LAN.

Step 2: Follow the guide on it. Select language.

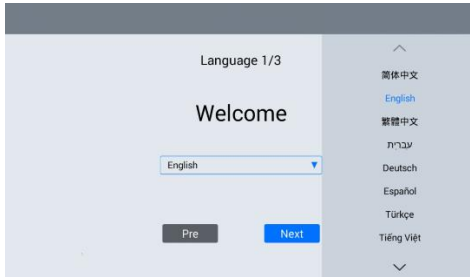

Step 3: Choose No.

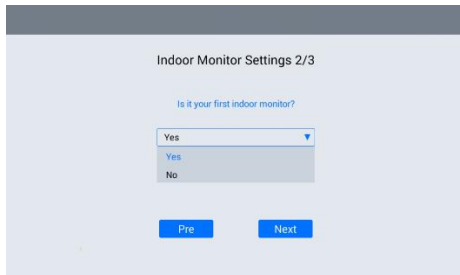

Step 4: Select first Indoor Monitor and MAC of first Indoor Monitor will appear.

Click MAC of first Indoor Monitor to Sync.



Step 5: Network of subordinate Indoor Monitor can be either dynamic or static. Select DHCP to enable dynamic network or fill in IP, Mask and Gateway to set up static network for subordinate Indoor Monitor. Network segment should be the same as first Indoor Monitor's when using static IP address. For example, IP

address should be 192.168.0.**if IP address of first Indoor Monitor is 192.168.0.**.

First Monitor Sync 3/3

DHCP

IP

Mask

Gateway

Pre Next

Step 6: It's coming to an end here. All the basic settings are done.

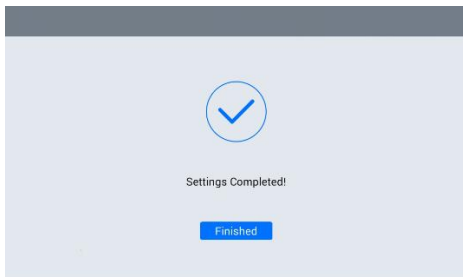

8. Add More Door Stations

8.1. Add more Door Stations

1. After having added first Door Station successfully, resident can add more Door Stations to it. The suggested amount of Door Station is two.

Step 1: Connect Door Station to the same LAN.

Step 2: Go to home page of Indoor Monitor and click Setup.

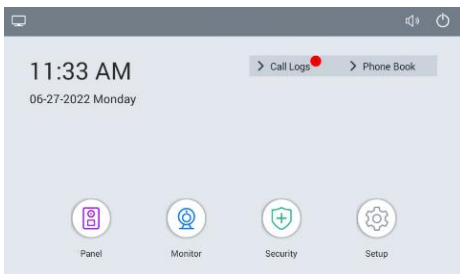

Step 3: Click Devices.



Step 4: Click the little search icon below.

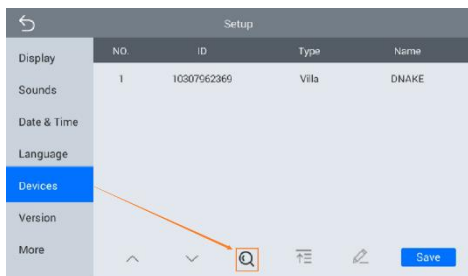

Step 5: Onboarding page will guide to set up Door Station. Please refer to 1.3 Door Station Sync 3/3.

SYSTEM DIAGRAM

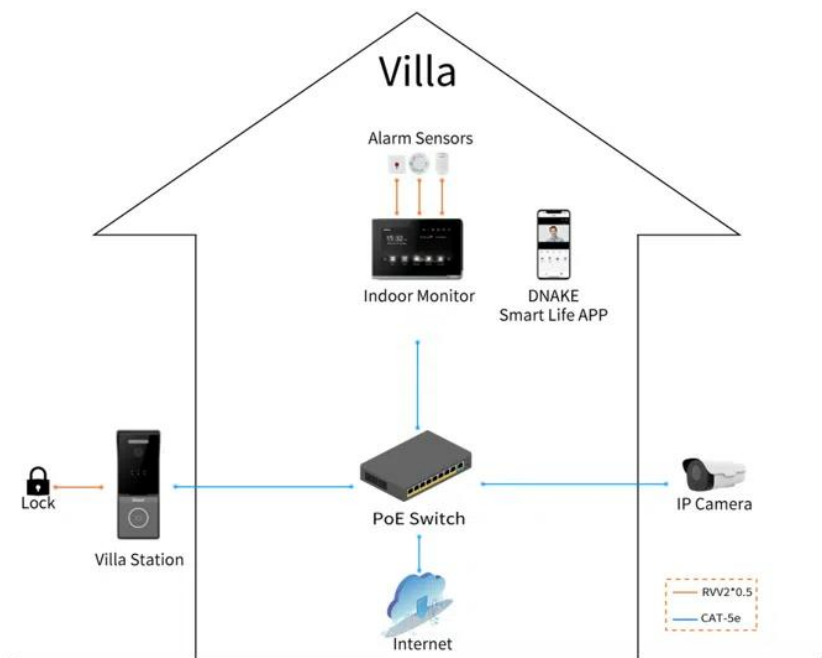

DEVICE WIRING

E216

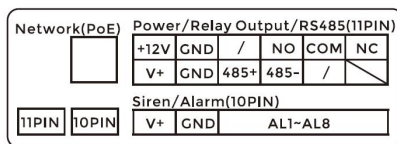

Single Port

1. Network (POE)

Standard RJ45 interface is for the connection with POE switch or other network switch.

PSE shall comply with IEEE 802.3af (POE) and its output power not less than 15.4W and its output voltage not be less than 50V.

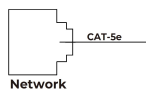

2. Power

The power interface of Indoor Monitor connects to 12V DC power.

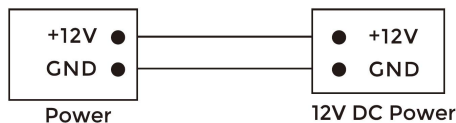

3. Relay Output

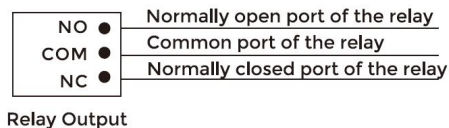

⚠ Warning!

1. When connecting to an inductive load device such as a relay or electromagnet lock, you are recommended to use a diode 1A/400V (included in the accessories) in anti-parallel with the load device to absorb inductive load voltage peaks. The intercom will be better protected in this way.
2. The load current of the relay cannot be greater than 2A. See attached picture for more details.

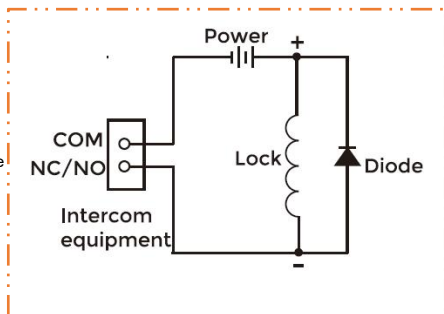

4. RS485

Enable to connect equipment with RS485 interface. RS485 interface can output 12V/100mA power supply. If RS485 equipment to be connected doesn't require the power supply, there is no need to connect to +12V.

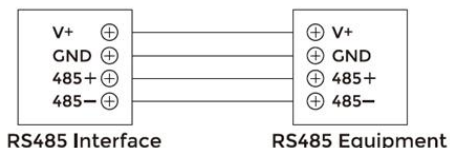

5. Siren/Alarm

Interface of alarm zones connects with normally-open or normally-closed switch. When the alarm zone is triggered, it will output 12V/100mA power.

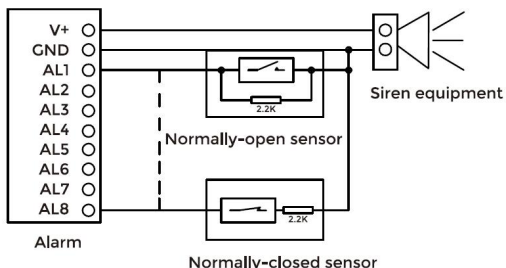

C112R

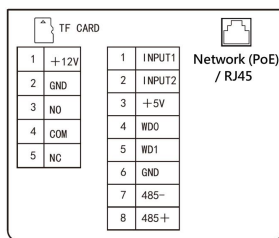

1. Network (POE) / RJ45 (Non-standard POE)

Standard RJ45 interface is for the connection with POE switch or other network switch.

PSE shall comply with IEEE 802.3af (POE) and its output power not less than 15.4W and its output voltage not be less than 50V.

RJ45 can be selected as non-standard POE, which can be directly connected to the non-standard POE network port of the indoor monitor.

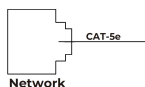

2. Power/Switching Value Output

The power interface of Door Station connects to 12V DC power.

Connect to the lock module (an independent power supply is necessary for the lock).

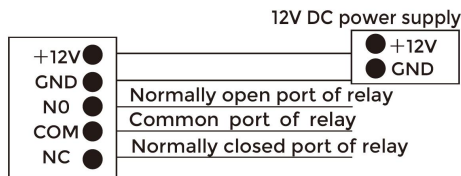

⚠ Warning!

1. When connecting to an inductive load device such as a relay or electromagnetic lock, you are recommended to use a diode 1A/400V (included in the accessories) in anti-parallel with the load device to absorb inductive load voltage peaks. The intercom will be better protected in this way.
2. The load current of the relay cannot be greater than 2A. See attached picture for more details.

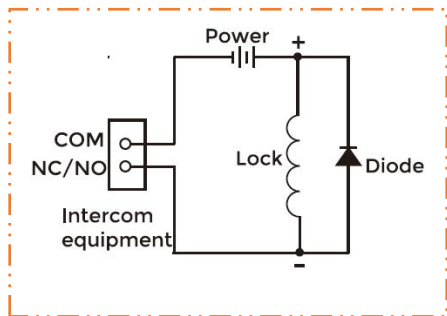

3. Custom input configuration interface/Wiegand/RS485

- The input interface can be configured with various functions, such as the exit button, door status sensor, and fire linkage interface.
- The interface can be connected to one IC/ID card reader or be used for reading the information of built-in card reader. Card swiping device connected to Wiegand interface.
- +5V can power the Wiegand card swiping device, note that the current must not exceed 100mA.
- Enable to connect equipment with RS485 interface. Connect to the lock module (independent power supply is necessary for the lock).

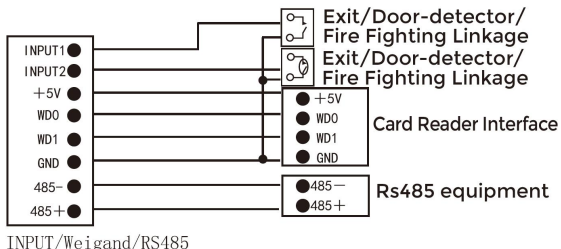

Note: Door Station can only be connected to one card reader or management device at a time.

INSTALLATION

Surface Mounting-86 Mounting Box

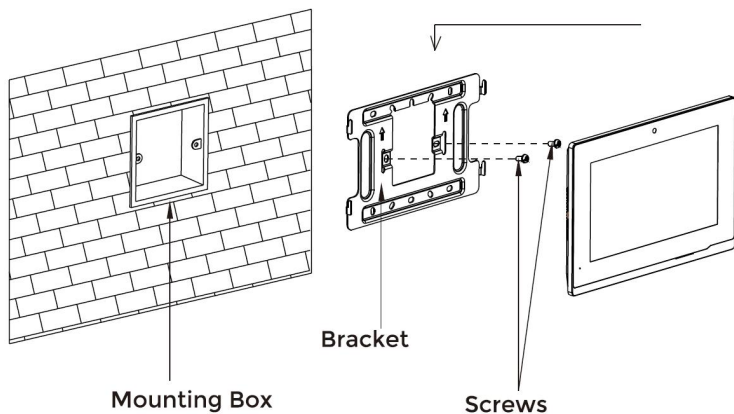

Product size: 195 × 130 × 14.5 mm

Installation of Rain Hood

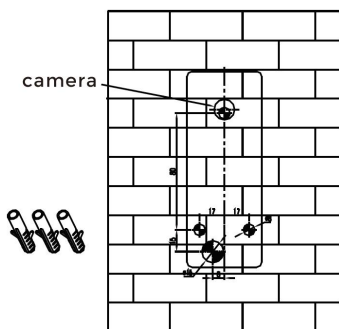

1. Choose the suitable height of camera, and put the label sticker on the wall.
2. According to the sticker, drill three 8 x 45mm for screws and one 5mm for wire outlet.
3. Insert 3 screw fixing seats into the screw holes.
4. Remove the sticker after drilling.

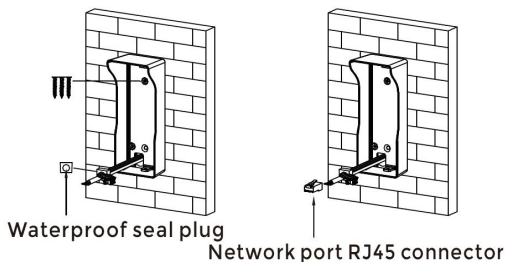

5. Lock the rain hood or rear cover with 3 screws.
6. Let wires(included) and network cable without RJ-45 plug go through rain hood and waterproof seal plug.
7. Connect RJ-45 Plug.

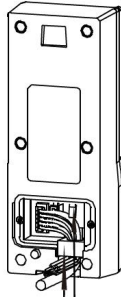

8. Connect wires and RJ-45 to the device.

9. Plug waterproof seal plug into the cover groove at the bottom.

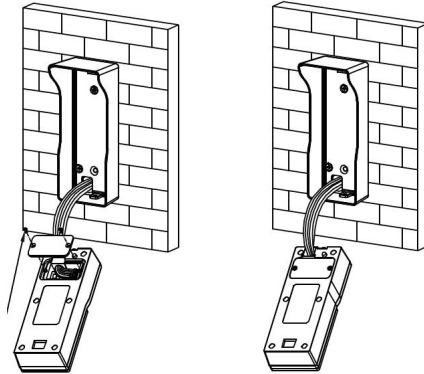

10. Fix interface clamp to the device with 2 screws.

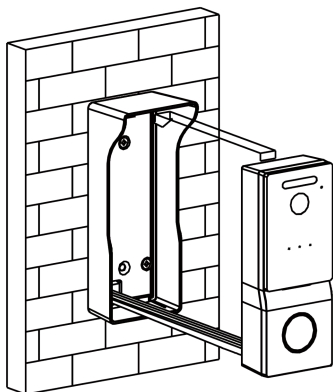

11. Hang up device with rain hood.

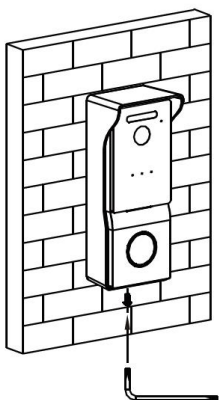

**Lock the device with 1 screw
(different screws for rain hood and bracket).**

12. Use wrench to lock the bottom of the device with 1 screw (different screws for rain hood and rear cover).

Installation of Rear Cover

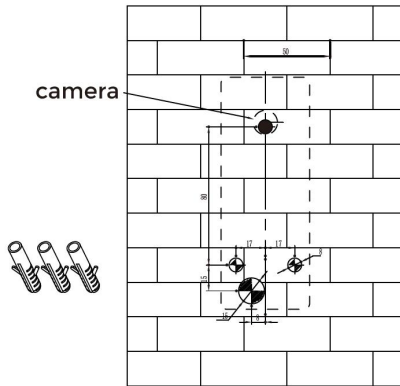

1. Choose the suitable height of camera, and put the label sticker on the wall.
2. According to the sticker, drill three 8 x 45mm for screws and one 5mm for wire outlet.
3. Insert 3 screw fixing seats into the screw holes.
4. Remove the sticker after drilling.

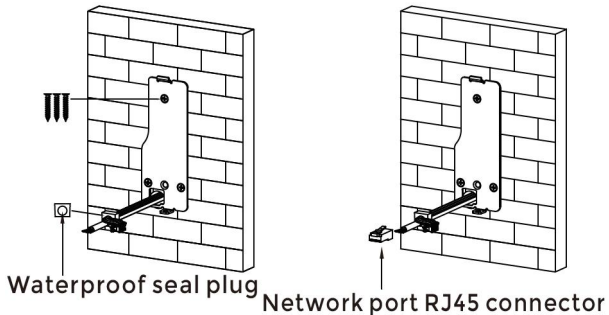

5. Lock the rain hood or rear cover with 3 screws.
6. Let wires(included) and network cable without RJ-45 plug go through rear cover and waterproof seal plug.
7. Connect RJ-45 Plug.

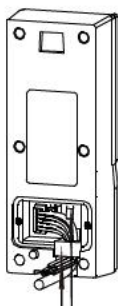

8. Connect wires and RJ-45 to the device.

9. Plug waterproof seal plug into the cover groove at the bottom.

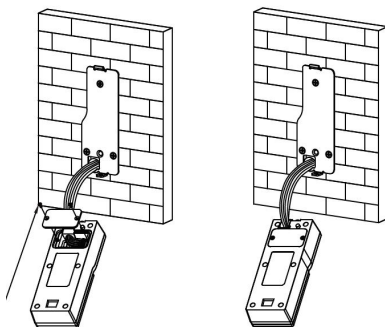

10. Fix interface clamp to the device with 2 screws.

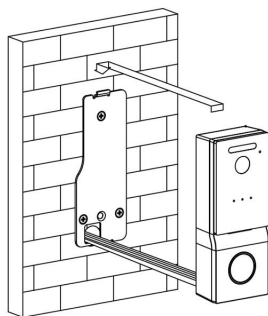

11. Hang up device with rear cover.

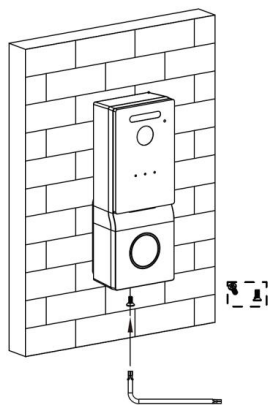

12. Use wrench to lock the bottom of the device with 1 screw (different screws for rain hood and rear cover).

Tips:

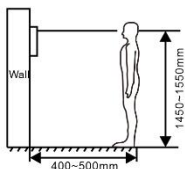

The camera should be 1450~1550mm above the ground.
The camera at this height can capture human face perfectly.

TROUBLESHOOTING

The Indoor Monitor cannot start up or power off automatically.

- Check whether it has power-failure, and power it on again
-

The Indoor Monitor display screen is too dim.

- Check whether the brightness and contrast settings of screen are correct.
-

No sound during the communication.

- Check whether the Indoor Monitor is set as mute mode, or the volume is set to the lowest.
-

The Indoor Monitor cannot monitor the Door Station.

- Other user is using the system, so you can use it once he/she finished the operation.
-

Multimedia files cannot be played normally.

- Check whether the system supports the file format. Please refer to the multimedia setting for details.
-

No response when clicking Indoor Monitor display screen.

- Press "Unlock" button for 5s, or slowly slide horizontally or vertically on the LCD to make touchscreen calibration. It needs to be calibrated.
-

Touchscreen responses slowly or cannot make calibration.

- Take down any protective paster, since it may affect identification and input for device;
 - Ensure the finger is dry and clean when clicking touchscreen;
 - Restart the device to clear any temporary software error.
-

The temperature of device is too high.

- Long-term use leads to high temperature. It's normal and will not affect the device's use life and performance.
-

SAFETY INSTRUCTION

In order to protect you and others from harm or your device from damage, please read the following information before using the device.

- Do not install the device in the following places:
- Do not install the device in high-temperature and moist environment or the area close to magnetic field, such as the electric generator, transformer or magnet.
- Do not place the device near the heating products such as electric heater or the fluid container.
- Do not place the device in the sun or near the heat source, which might cause discoloration or deformation of the device.
- Do not install the device in an unstable position to avoid the property losses or personal injury caused by the falling of device.

Guard against electric shock, fire and explosion:

- Do not use damaged power cord, plug or loose outlet.
- Do not touch the power cord with wet hand or unplug the power cord by pulling.
- Do not bend or damage the power cord.
- Do not touch the device with wet hand.
- Do not make the power supply slip or cause the impact.
- Do not use the power supply without the manufacturer's approval.
- Do not have the liquids such as water go into the device.

Clean Device Surface

- Clean the device surfaces with soft cloth dipped in some water, and then rub the surface with dry cloth.

Other Tips

- In order to prevent damage to the paint layer or the case, please do not expose the device to chemical products, such as the diluent, gasoline, alcohol, insect-resist agents, opacifying agent and insecticide.
- Do not knock on the device with hard objects.
- Do not press the screen surface. Overexertion might cause floppover or damage to the device.
- Please be careful when standing up from the area under the device.
- Do not disassemble, repair or modify the device at your own discretion.
- The arbitrary modification is not covered under warranty. When any repair required, please contact the customer service center.
- If there is abnormal sound, smell or fume in the device, please unplug the power cord immediately and contact the customer service center.
- When the device isn't used for a long time, the adaptor and memory card can be removed and placed in dry environment.
- When moving, please hand over the manual to new tenant for proper usage of the device.

FCC WARNING

This device complies with Part 15 of the FCC Rules. Operation is subject to the following two conditions:

(1) This device may not cause harmful interference, and (2) this device must accept any interference received, including interference that may cause undesired operation.

NOTE 1: This equipment has been tested and found to comply with the limits for a Class B digital device, pursuant to part 15 of the FCC Rules. These limits are designed to provide reasonable protection against harmful interference in a residential installation. This equipment generates uses and can radiate radio frequency energy and, if not installed and used in accordance with the instructions, may cause harmful interference to radio communications. However, there is no guarantee that interference will not occur in a particular installation. If this equipment does cause harmful interference to radio or television reception, which can be determined by turning the equipment off and on, the user is encouraged to try to correct the interference by one or more of the following measures:

- Reorient or relocate the receiving antenna.
- Increase the separation between the equipment and receiver.
- Connect the equipment into an outlet on a circuit different from that to which the receiver is connected.
- Consult the dealer or an experienced radio/TV technician for help.

NOTE 2: Any changes or modifications to this unit not expressly approved by the party responsible for compliance could void the user's authority to operate the equipment.

RF exposure statement

This equipment complies with the FCC radiation exposure limits set forth for an uncontrolled environment. This transmitter must not be co-located or operating in conjunction with any other antenna or transmit.

 **EASY & SMART
INTERCOM SOLUTIONS**